



DOLLE®

**INSTALLATION
INSTRUCTION
LOFT LADDER**

INSTALLATION INSTRUCTIONS FOR LOFT LADDER

NB!

PLEASE READ THESE INSTALLATION INSTRUCTIONS CAREFULLY BEFORE INSTALLING THE LOFT LADDER.

Do not use the ladder as an access passage during building or renovation work. Do not use the ladder if the ceiling height exceeds the maximum ceiling height stated in the installation instructions or on the product label.

For safety's sake, always face the ladder when climbing up and down and grip at least one string of the ladder (or grip the handrail). The ladder must be used only by one person at a time.

Do not use the ladder if it is faulty or damaged. The springs are very taut. Take care when adjusting springs. Only adjust the spring mechanism when the ladder is folded (i.e. the springs are under least tension). Great care should be taken when removing springs. If the ladder is delivered unassembled, read the enclosed assembly instructions carefully before assembling and installing the ladder.

The ladder is tested to 150 kg (maximum load). A load in excess of 150 kg may cause damage to the ladder and constitutes a risk of personal injury.

NB! Lubricate all moving metal parts with oil immediately after assembly. Parts must subsequently be lubricated at least once a year.

1. Fitters, tools and materials:

We recommend that 2 fitters install the attic ladder together. One fitter must be strong enough to lift the attic ladder to the ceiling (as the attic ladder weighs up to 50 kg, depending on model).

clickFIX® models can be fitted by one fitter working alone.

You will require the following materials and tools:

- Electric screwdriver
- Pencil
- Hand saw
- Folding rule or similar
- Square
- 100 mm screws
- Protective gloves
- Oil
- Timber for transverse joists – same dimensions as ceiling joists (if needed)
- Temporary support beams (approx. 20 cm longer than width of attic opening)
- Wooden blocks and wedges
- A large step ladder
- A solid work platform
- Planks for work platform (if necessary)

The work platform should be high enough to allow you to climb up into the attic without exceeding the maximum permitted work platform height. The work platform must bear a load corresponding to the weight of the fitter plus the weight of the attic ladder.

2. Installation instructions:

To ensure that the product is assembled and fitted correctly, these instructions should be followed carefully. If you have any difficulties, contact your dealer for assistance.

WARNING: DO NOT DISMANTLE the attic ladder once it has been assembled.

NB! For models in which the ladder is fixed to the trapdoor (not clickFIX® model). If, during installation, you wish to detach the ladder to reduce the weight of the attic ladder, loosen the screws between the metal bracket and the ladder itself. Do not loosen the screws on the trapdoor as these can easily be overtightened when reassembled. An overtightened screw may lose its grip on the timber and, in serious cases, fall out.

Positioning the loft ladder:

Wear gloves when removing insulation material. Check that the area selected for positioning the ladder is unencumbered by electrical wiring, water pipes, heating/cooling pipes, etc. If necessary, get a qualified craftsman to remove such encumbrances. Make sure that there is sufficient clearance (distance A) for the ladder to rest on the floor. Make sure that there is sufficient space for the ladder to fold out to its full length (B) (see figure 1). For two-section models, make sure that there is sufficient swing space.

For specific measurements and adjustment options, see the assembly instructions supplied with the product.

3. To make opening in ceiling:

We recommend that you wear goggles and mask for pro-

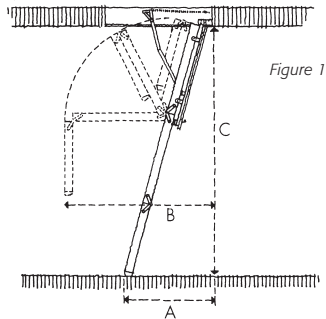

tection from falling dust and other particles from the attic. Remove all items of furniture from the work area. Cover the floor.

Frame and cut the opening through plaster/other ceiling material. The size of the ceiling opening is stated on the packaging. The opening must be at least 10 mm longer and 10 mm wider than the ladder casing. This allows space for spacer blocks and ensures that the attic ladder is fitted perpendicularly. If the attic ladder cannot be fitted in the normal way, i.e. parallel with the ceiling joists, contact a qualified craftsman for advice. Figures 2, 3 and 4 show how to frame the ceiling opening. If you fit the attic ladder parallel to the existing ceiling joists, only single ceiling joists and single transverse joists

Figure 2

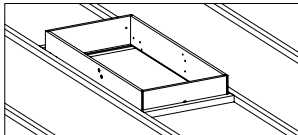

Figure 3

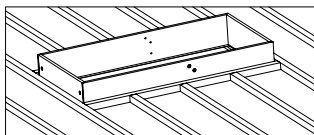
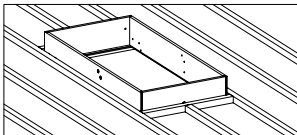

Figure 4

are required. If you fit the attic ladder at right angles to the joists, you will need to make double transverse joists of the same size as the existing ceiling joists.

WARNING: If the ceiling joists are made in a material other than timber, e.g. steel, contact a qualified craftsman. Never saw through a load-bearing joist without advice from a qualified craftsman. Take great care when sawing ceiling joists. For safety's sake, if there is no attic flooring, lay planks across the ceiling joists to allow safe passage in the attic during installation.

4. Fitting temporary supports:

To keep the attic ladder in place in the ceiling opening during installation, you are advised to fit temporary supports. If the trapdoor will be clad, the attic ladder must be fitted as many mm higher in the opening as the thickness of the cladding.

Cladding material must not weigh more than 6 kg per m². Cladding material must not be more than 12 mm thick. We recommend that the cladding is affixed using construction adhesive.

WARNING: It is important that cladding is fitted firmly and correctly. When affixing cladding, the ladder must NOT be loaded.

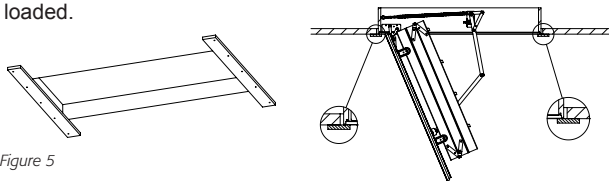

Figure 5

5. Attaching the loft ladder:

One fitter goes up into the attic room, taking all the tools he needs. The other fitter remains below. clickFIX® models can be installed by one person (using a work platform).

Lift the ladder up into the attic. Before lowering the loft ladder into the opening from above, attach 2 supporting planks under the ceiling opening. The attic ladder rests on these supports (see figure 5). Fold the ladder so that the frame can be attached to the ceiling opening. Make sure that the attic ladder is level and perpendicular. Attach the attic ladder with

100 mm screws (3 on each long side and 2 at each end). Don't forget to attach blocks on the back of the fixing points (see figure 6).

When the loft ladder is firmly attached, remove supports.

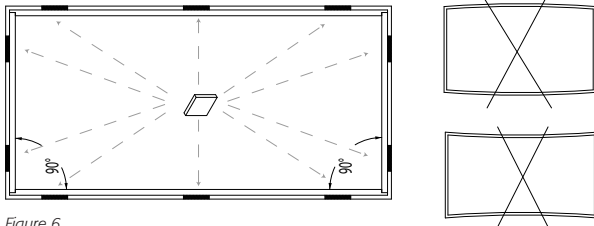

Figure 6

WARNING: Do not use the attic ladder before it is firmly attached to the opening and adjusted to the correct ceiling height.

Vapour barrier:

When the loft ladder is firmly attached to the deck, the vapour barrier must be attached in the correct way. The space between the loft ladder and the joist construction must be well-insulated to avoid thermal bridges.

6. Adjusting to correct ceiling height:

Pull down and unfold the ladder. Fold the lower section of the ladder under the middle section, so that the top and middle sections are aligned (see figure 7).

Make sure that the treads are horizontal. To shorten the ladder precisely, follow the instructions for the specific model.

Note whether the ladder is supplied with plastic feet. For most models, the ladder can be fine-tuned after shortening.

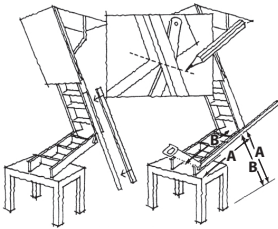

Figure 7

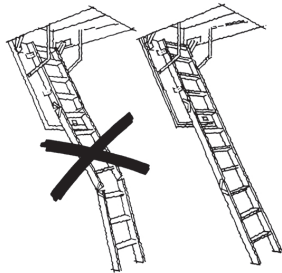

Figure 8

DO NOT SHORTEN THE LADDER TOO MUCH. If the ladder is too short, it may unexpectedly fold up during use, thus risking serious personal injury.

To check that the ladder is the correct length, unfold it to its full length. All sections of the ladder must be aligned perfectly with no gaps, and both strings must rest flat on the floor (see figure 8).

WARNING: Do NOT use the ladder if all sections of the ladder are not aligned. If the ladder is too long, shorten the strings once more. If the ladder is too short, order a new lower section from your dealer. Do NOT allow the ladder to rest on a box, blocks, platform or similar. Such constructions are unsafe and unstable, and do not provide appropriate permanent support for the ladder.

7. How to use the ladder:

The following drawings show how to use the attic ladder safely (see figure 9).

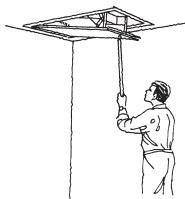

Figure 9A

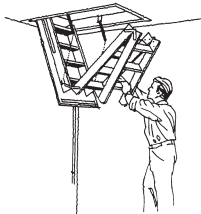

Figure 9B



Figure 9C

8. Further advice:

Depending on the model, the following may be relevant:

WARNING: The spring mechanism can be re-adjusted inside its frame using a chain link or by moving the springs up or down (depends on the model in question). Always adjust the spring mechanism when the trapdoor is closed. It may be necessary to adjust the spring mechanism if the trapdoor is to be clad. Take great care when making adjustments as the springs are very taut. Accidental release of the springs may cause personal injury.

Chipboard trapdoors are suitable for painting. To avoid distortion, paint the trapdoor on both sides.

9. Accessories:

To improve safety, we recommend that you fit the following accessories:

- Hand rail (see figure 10)
- Balustrade (see figure 11)



Figure 10



Figure 11

To order the above accessories, contact your dealer.

WARNING:

Never modify the product. The manufacturer accepts no liability whatsoever for personal injury or damage caused to the building or parts thereof by a product, whose construction has been modified.